

Click on a link  
tab to jump to  
that page

Cover  
Page

Before  
You Begin

Remove  
& Install

Wire  
New Radio

Mount  
New Radio

Publication, Duplication, or Retransmission Of This Document Not Expressly Authorized In Writing By The Install Doctor Is Prohibited. Protected By U.S. Copyright Laws. © 1997,1998,1999,2000.

## Factory Radio



## Other Documents Available For This Vehicle:

No documents available at this time

## New Radio

and kit with included pocket in kit



## Adobe Acrobat Reader Printing Tips:

- 1) Select "**FILE**" then "**PRINT**" and select your printer.
- 2) In the print options box do the following:
  - A) Locate check box "**Shrink to Fit**". Place check in box.
  - B) Locate box "**Print Quality**". Select highest print dpi allowed by printer.
  - C) If print quality listed is not as high as that printers normal quality, press the "**SETUP..**" button. In the next screen, press the "**PROPERTIES**" button and set the printers print quality to the highest print dpi allowed.

## Document Revision History

02/00 Document Creation

## New Radio and kit without pocket



Click on a link  
tab to jump to  
that page

Cover  
Page

Before  
You Begin

Remove  
& Install

Wire  
New Radio

Mount  
New Radio

Publication, Duplication, or Retransmission Of This Document Not Expressly Authorized In Writing By The Install Doctor Is Prohibited. Protected By U.S. Copyright Laws. © 1997,1998,1999,2000.

## Overview Of This Radio Install

Step	What Section To Go To
Remove old radio from dash	Remove & Install
Wire the new radio	Wire New Radio
Mount the new radio	Mount New Radio
Finishing the installation	Remove & Install

## Parts Needed For This Radio Install

Parts REQUIRED for the install	Description
Snap on wire harness adapter	Honda 86 and newer harness
Radio installation kit	Multi Honda/Acura kit

### Optional parts for this install

None

## Tools Needed To Complete This Install

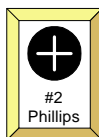

#2  
Phillips

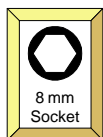

8 mm  
Socket

Hand tools needed  
to remove radio

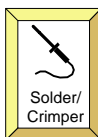

Solder/  
Crimper

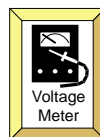

Voltage  
Meter

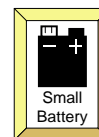

Small  
Battery

Accessory tools needed to test and  
wire the new radio



### TOOL TIPS:

**Small Battery:** use a battery to test speaker wires. Touching the (+) positive and (-) negative battery leads to a pair of speaker will cause the speaker to make a "Pop" sound indicating that pair of wires goes to that speaker.  
**Voltage Meter:** Always check +12 Volt power wires for voltage before making wire connections. These wires will fluctuate between 10 and 14 Volts.  
**Solder Iron or Crimp Tool:** make wire to wire connections using either a solder iron and electrical tape, OR plastic crimp terminals found at most hardware or auto parts stores.

**PLUS: Wire ties or electrical tape:** to neatly bundle and organize your wires for a professional appearance.

## Installation Difficulty Ratings

**Easy.** No advanced skills or specialty tools needed.

**Basics.** Simple tools required. Installs quickly.

**Intermediate.** Requires knowledge of tools, or disassembly of panels.

**Advanced.** Requires advanced tools, or extra time.

**Difficult.** Involves modifying or cutting of the installation area. Advanced tools and/or skills required. Best if performed by experienced installers.

### Do It Yourselfers

Basics

### Professional Installer

Basics

## Support Information If You Need Help

Supplemental information if you need help

Document Title	Document #
Basic DC electronics for automotive applications	999001
Wire splicing: soldering vs. crimping	999004
Why use radio installation kits	999005
Mounting your radio to an installation kit	999007
Why use an optional snap on wire harness	999008
Wiring your new radio using a wire harness	999009
Testing wires when installing a new radio	999013

## ► Remove Factory Radio

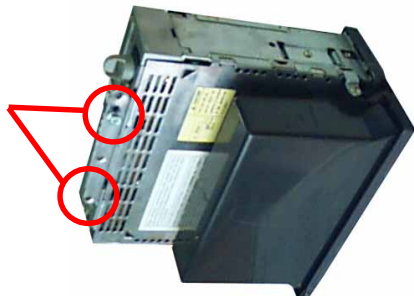

### NOTE:

To remove the Honda factory radio, (2) two screws at the rear of the radio must be removed from underneath the radio which can be accessed from behind the radio.

The Honda radio is secured to the pocket below the radio and will pull out of the dash connected together as one unit.

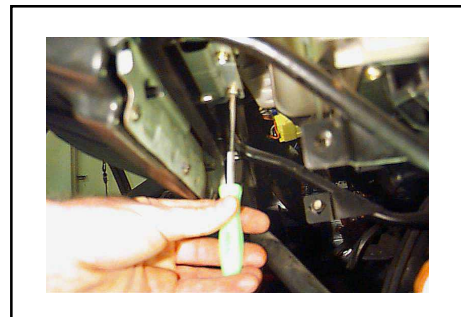

### STEP 1:

Move to the passenger side of the vehicle. The screws that secure the radio/pocket assembly to the dash are at the rear of the radio. The only way to access these screws is to look up at the rear of the radio from the passenger side of the vehicle. With an 8mm socket or phillips screw, locate and remove the screws as can be seen in the photos shown in the NOTE to the left.



### STEP 2:

Once the screws at the rear of the radio/pocket assembly have been removed, the radio can be pulled forward out of the dash.



### STEP 3:

Pull the radio out of the dash. Unplug the black cable plugged into the rear of the radio.

Unplug the white plastic wire harness connector plugged into the rear of the radio.

## ▶ Wiring The New Radio

Move to: **Wire New Radio** Section

## ▶ Mounting The Radio

Move to: **Mounting New Radio** Section

## ▶ Completing The Radio Installation



### STEP 1:

Insert the radio installation kit into the dash until it snaps and secures to the dash.

**TIP:** mount the kit to the opening in the dash **BEFORE** mounting the radio to the kit. Mounting the radio to the kit before snapping the kit into the dash may prevent the kit from properly snapping into the dash.

This step is shown in more detail in the **"Mount New Radio"** section.



### STEP 2:

Insert the new radio into the dash. Plug the black antenna cable into the rear of the new radio. Make sure all wire connections for the new radio have been completed and plug in any connectors for the new radio now. Slide the new radio into the radios mounting "cage" or mounting "sleeve".

### The Installation Is Now Complete

Click on a link  
tab to jump to  
that page

Cover  
Page

Before  
You Begin

Remove  
& Install

Wire  
New Radio

Mount  
New Radio

Publication, Duplication, or Retransmission Of This Document Not Expressly Authorized In Writing By The Install Doctor Is Prohibited. Protected By U.S. Copyright Laws. © 1997,1998,1999,2000.

## Step By Step Wiring

Page 1 of 2

Auto Makers  
Factory  
Radio

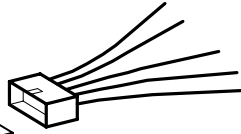
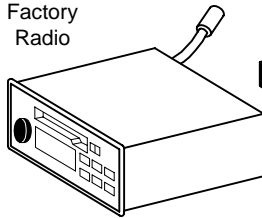

Wire Harness Inside Vehicles  
Dash Which Plugs Into The  
Rear Of The Factory Radio

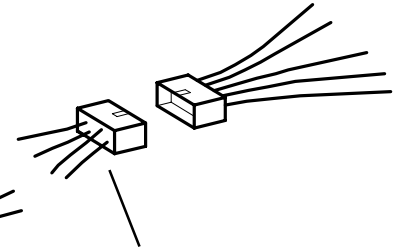
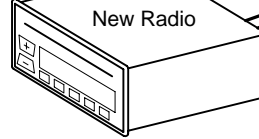

Optional (STRONGLY  
RECOMMENDED) Snap On Wire  
Harness That Splices Into The  
Wires Of The New Radio

(Note: the radio shown is for display purposes and may not be similar in size or dimensions than the auto makers factory radio in your vehicle)

Supplemental information if you need help

Document Title	Document #
Testing wires when installing a new radio	999013
Why use an OEM snap on wire harness	999008
Wiring your new radio using a wire harness	999009
Wire splicing: soldering vs. crimping	999004

## Wiring Instructions:

The power and speaker wires needed to connect the new radio are attached to the connector of the wire harness located inside the vehicles dash. The Install Doctor **STRONGLY** recommends using an optional snap on wire harness that is specifically designed to snap into the vehicles dash wire harness connector. This will keep you from cutting the vehicles wires. This optional snap on wire harness will have wires on the opposite side of the connector that will allow you to splice these wires to the new radios wires. The only other option is to cut off the vehicles dash wire harness connector and splice the new radios wires directly to these wires. The optional snap on wire harness takes all the guess work out of trying to figure out what each wire is in the vehicles dash wire harness. The optional snap on wire harness shows you what each wire is.

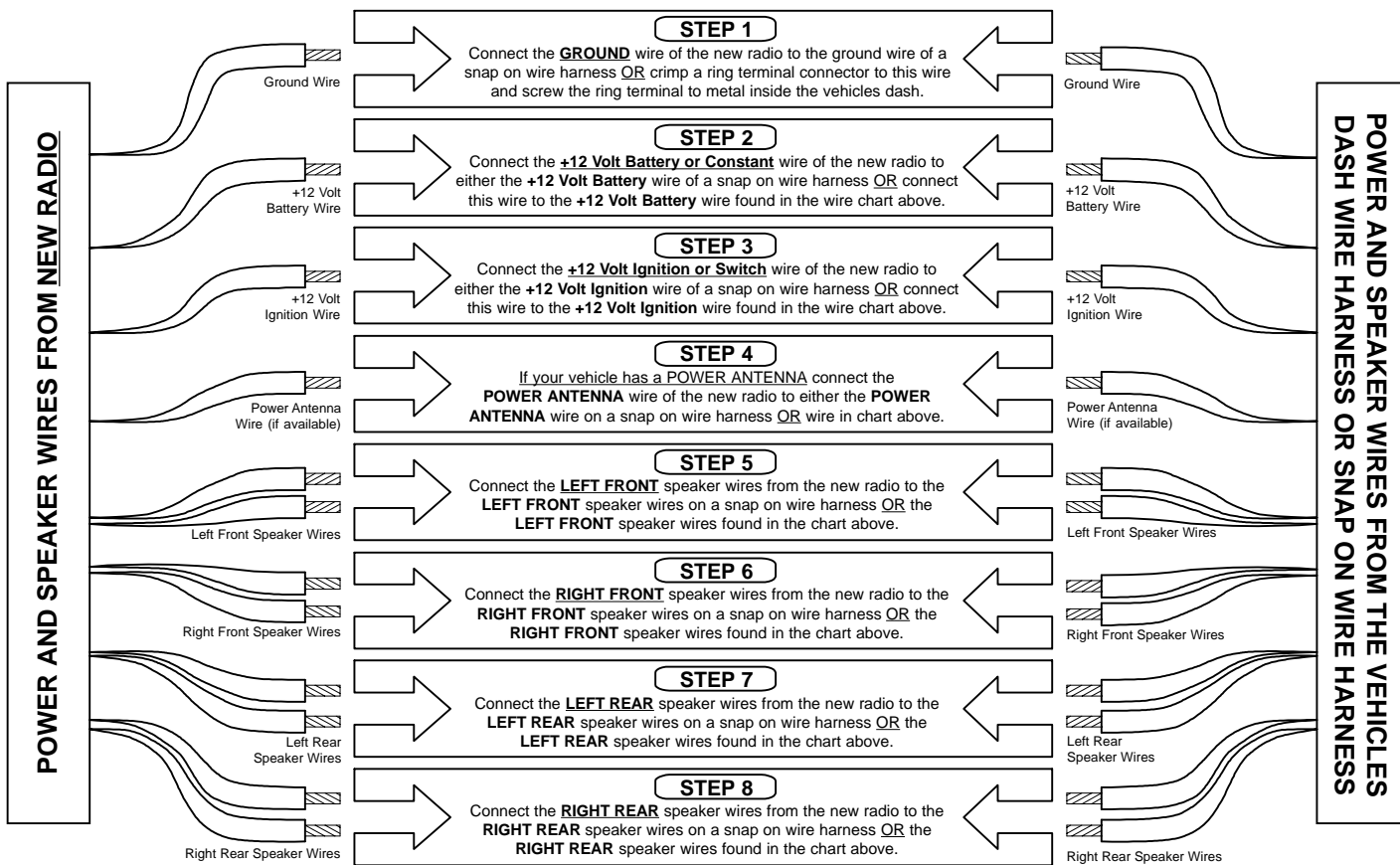

Click on a link  
tab to jump to  
that page

Cover  
Page

Before  
You Begin

Remove  
& Install

Wire  
New Radio

Mount  
New Radio

Publication, Duplication, or Retransmission Of This Document Not Expressly Authorized In Writing By The Install Doctor Is Prohibited. Protected By U.S. Copyright Laws. © 1997,1998,1999,2000.

## ▶ Radio Wire & Color Code Information

Page 2 of 2

Factory in-dash wire harness that  
snaps into the factory radio.

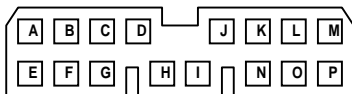

AS VIEWED FROM MATING END OF CONNECTOR

Pin	What It Is	Typical Honda/Acura In Dash Wire Color	"Typical" New Radio Equivalent Wire Color
A	Right Rear Spkr (+)	Red w/ Yellow Stripe	Purple
B	Left Rear Spkr (+)	Blue w/ Yellow Stripe	Green
C	Power Antenna Trigger	Brown w/ White Stripe	Blue or Blue w/ Wht Stripe
D	+12 Volt Ignition Wire	Yellow w/ Red Stripe	Red
E	Right Rear Spkr (-)	Brown w/ White Stripe	Purple w/ Black Stripe
F	Left Rear Spkr (-)	Gray w/ White Stripe	Green w/ Black Stripe
G	Ground Wire	Black	Black
H		<i>Do Not Use</i>	
I		<i>Do Not Use</i>	
J	+12 Volt Battery Wire	White w/ Yellow or Blu Stripe	Yellow
K	Dash Light Dimmer Wire		Orange
L	Left Front Spkr (+)	Blue w/ Green Stripe	White
M	Right Front Spkr (+)	Red w/ Green Stripe	Gray
N		<i>Do Not Use</i>	
O	Left Front Spkr (-)	Gray w/ Black Stripe	White w/ Black Stripe
P	Right Front Spkr (-)	Brown w/ Black Stripe	Gray w/ Black Stripe

**Note:** using an optional snap on wire harness adapter will simplify the wiring. Most snap on wire harness adapters have already converted and color coded the wires from the auto makers in dash wire harness to match typical aftermarket radio wire colors.

\*\* The wire colors listed in the chart above are typical for these vehicles during these years but may not be the exact colors for this vehicle. This is another reason to use a snap on wire harness adapter. \*\*

Click on a link  
tab to jump to  
that page

Cover  
Page

Before  
You Begin

Remove  
& Install

Wire  
New Radio

Mount  
New Radio

Publication, Duplication, or Retransmission Of This Document Not Expressly Authorized In Writing By The Install Doctor Is Prohibited. Protected By U.S. Copyright Laws. © 1997,1998,1999,2000.

## ▶ Mounting A Radio To A Kit

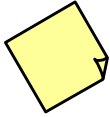

### NOTE:

This vehicle requires a kit designed specifically for Honda/Acura vehicles.

All information needed to complete the mounting of the new radio to the installation kit is included on this sheet. If you need additional help, please consult the following tech documents:

Document Title	Document #
Why use radio installation kits	999005
Mounting your radio to an installation kit	999007
Radio security	999010

Honda/Acura Radio  
Installation Kit

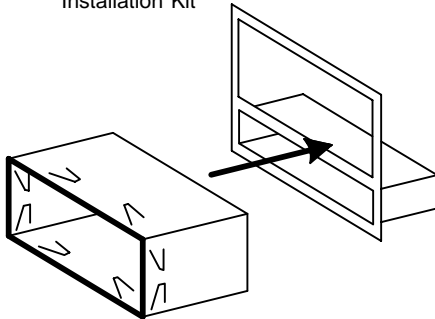

'DIN' Sleeve From New  
Replacement Radio

Slide The 'DIN' Sleeve From The New Radio Into The Kit And Bend Tabs On The Sleeve Behind The Rear Of The Kit To Secure The Sleeve To The Kit.

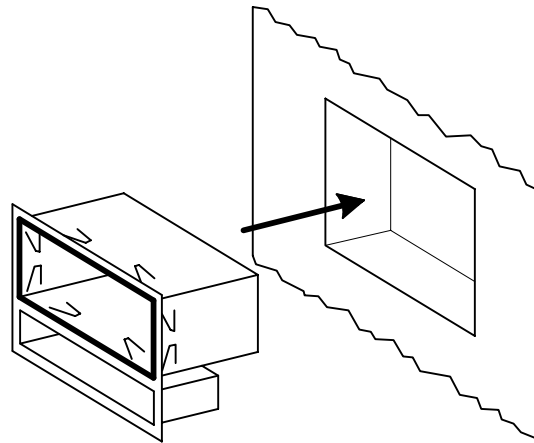

Push The Kit Into The Dash Opening. Depending Upon The Kit Design, The Kit Should Secure To The Dash By Snapping Into The Opening.