

Radio Replacement

Document #: 327013

Click on a link
tab to jump to
that page

Cover
Page

Before
You Begin

Remove
& Install

Wire
New Radio

Mount
New Radio

Publication, Duplication, or Retransmission Of This Document Not Expressly Authorized In Writing By The Install Doctor Is Prohibited. Protected By U.S. Copyright Laws. © 1997,1998,1999,2000.

Factory Radio



Other Documents Available For This Vehicle:

no documents available at this time

New Radio and radio installation kit



Adobe Acrobat Reader Printing Tips:

- 1) Select "**FILE**" then "**PRINT**" and select your printer.
- 2) In the print options box do the following:
 - A) Locate check box "**Shrink to Fit**". Place check in box.
 - B) Locate box "**Print Quality**". Select highest print dpi allowed by printer.
 - C) If print quality listed is not as high as that printers normal quality, press the "**SETUP..**" button. In the next screen, press the "**PROPERTIES**" button and set the printers print quality to the highest print dpi allowed.

Document Revision History

09/99 Document Creation
12/99 Photo Update

Click on a link
tab to jump to
that page

Cover
Page

Before
You Begin

Remove
& Install

Wire
New Radio

Mount
New Radio

Publication, Duplication, or Retransmission Of This Document Not Expressly Authorized In Writing By The Install Doctor Is Prohibited. Protected By U.S. Copyright Laws. © 1997,1998,1999,2000.

Overview Of This Radio Install

Step	What Section To Go To
Remove old radio from dash	Remove & Install
Wire the new radio	Wire New Radio
Mount the new radio	Mount New Radio
Finishing the installation	Remove & Install

Parts Needed For This Radio Install

Parts REQUIRED for the install	Description
Dash installation kit	Multi purpose Dodge/Chrysler
Snap on in dash wire harness	Dodge/Chrysler/Plymouth
Optional parts for this install	
None	

Tools Needed To Complete This Install

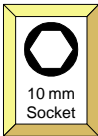

Hand tools needed
to remove radio

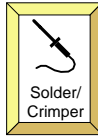

Accessory tools needed to test and
wire the new radio

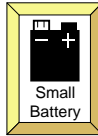
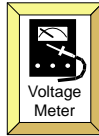

TOOL TIPS:

Small Battery: use a battery to test speaker wires. Touching the (+) positive and (-) negative battery leads to a pair of speaker will cause the speaker to make a "Pop" sound indicating that pair of wires goes to that speaker.
Voltage Meter: Always check +12 Volt power wires for voltage before making wire connections. These wires will fluctuate between 10 and 14 Volts.
Solder Iron or Crimp Tool: make wire to wire connections using either a solder iron and electrical tape, OR plastic crimp terminals found at most hardware or auto parts stores.

PLUS: Wire ties or electrical tape: to neatly bundle and organize your wires for a professional appearance.

Installation Difficulty Ratings

Easy. No advanced skills or specialty tools needed.

Basics. Simple tools required. Installs quickly.

Intermediate. Requires knowledge of tools, or disassembly of panels.

Advanced. Requires advanced tools, or extra time.

Difficult. Involves modifying or cutting of the installation area. Advanced tools and/or skills required. Best if performed by experienced installers.

Do It Yourselfers

Basics

Professional Installer

Basics

Support Information If You Need Help

Supplemental information if you need help

Document Title	Document #
Basic DC electronics for automotive applications	999001
Wire splicing: soldering vs. crimping	999004
Why use radio installation kits	999005
Mounting your radio to an installation kit	999007
Why use an OEM snap on wire harness	999008
Wiring your new radio using a wire harness	999009
Testing wires when installing a new radio	999013

▶ Remove Factory Radio



STEP 1:

The plastic dash panel that surrounds the radio and air conditioner controls must be removed before you can remove the radio. This plastic dash panel simply unsnaps from the dash without using any tools. Pull gently on any corner of the dash panel and it will unsnap from the dash. Set it aside, out of the way.



STEP 2:

The radio is secured to the dash with 2 bolts. Locate and remove two (2) 10mm bolts that secure the radio.

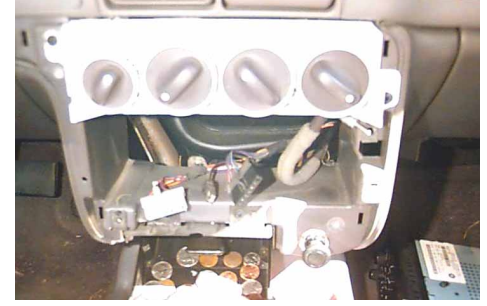

STEP 3:

Once the 2 bolts are removed, pull the radio out of the dash. Unplug the antenna cable plugged into the rear of the radio. Unplug 1 gray and 1 black connector snapped into the rear of the radio. Unplug the small plastic connector with one wire snapped into the rear of the radio. The radio is now free to be completely removed from the dash.

▶ Wiring The New Radio

Move to: [Wire New Radio Section](#)

▶ Mounting The Radio To A Kit

Move to: [Mounting New Radio Section](#)

▶ Completing The Radio Installation



STEP 1:

Mount the new radio to the dash installation kit as shown in the "**Mount New Radio**" section.

Plug the antenna cable into the rear of the new radio. Make sure all wire connections to the new radio have been completed and plug in any connectors to the rear of the new radio. Secure the radio installation kit with the same two (2) 10mm bolts that had originally secured the original factory radio.



STEP 2:

The plastic dash panel may now be snapped back onto the main dash.

The installation is now complete.

Step By Step Wiring

Page 1 of 2

Auto Makers
Factory
Radio

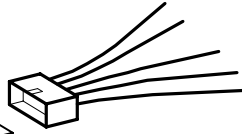
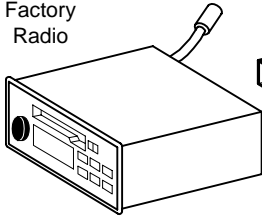

Wire Harness Inside Vehicles
Dash Which Plugs Into The
Rear Of The Factory Radio

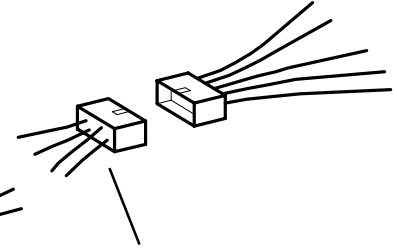
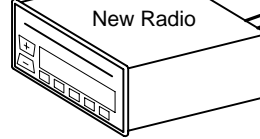

Optional Snap On Wire Harness
(Strongly Recommended)
That Splices Into The Wires Of
The New Radio

(Note: the radio shown is for display purposes and may not be similar in size or dimensions than the auto makers factory radio in your vehicle)

Supplemental information if you need help

Document Title	Document #
Testing wires when installing a new radio	999013
Why use an OEM snap on wire harness	999008
Wiring your new radio using a wire harness	999009
Wire splicing: soldering vs. crimping	999004

Wiring Instructions:

The power and speaker wires needed to connect the new radio are attached to the connector of the wire harness located inside the vehicles dash. The Install Doctor **STRONGLY** recommends using an optional snap on wire harness that is specifically designed to snap into the vehicles dash wire harness connector. This will keep you from cutting the vehicles wires. This optional snap on wire harness will have wires on the opposite side of the connector that will allow you to splice these wires to the new radios wires. The only other option is to cut off the vehicles dash wire harness connector and splice the new radios wires directly to these wires. The optional snap on wire harness takes all the guess work out of trying to figure out what each wire is in the vehicles dash wire harness. The optional snap on wire harness tell you what each wire is.

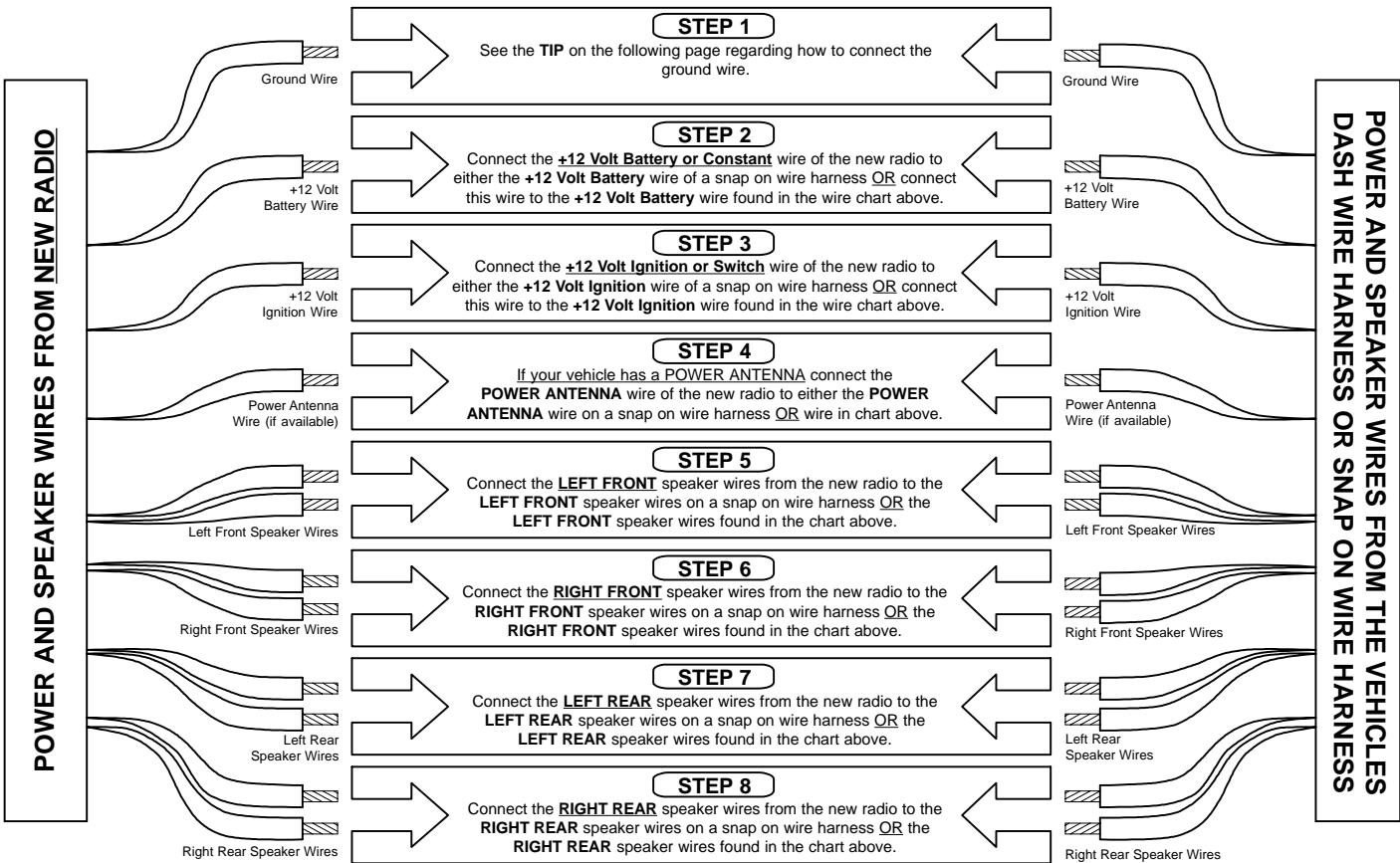

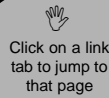

Cover Page

Before You Begin

Remove & Install

Wire New Radio

Mount New Radio

Publication, Duplication, or Retransmission Of This Document Not Expressly Authorized In Writing By The Install Doctor Is Prohibited. Protected By U.S. Copyright Laws. © 1997,1998,1999,2000.

▶ Radio Wire & Color Code Information Page 2 of 2

Factory in-dash wire harness (this vehicle has a 2 pc harness) that snaps into the factory radio

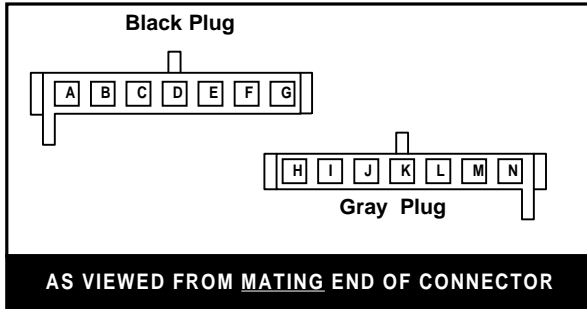

Pin	What It Is	Typical Dodge/Chrysler In Dash Wire Color	Typical New Radio Equivalent Wire Color
A	Right Rear Spkr (-)	Blue w/ White Stripe	Purple w/ Black Stripe
B	Left Rear Spkr (-)	Brown w/ Yellow Stripe	Green w/ Black Stripe
C	Right Front Spkr (+)	Purple	Gray
D	Left Front Spkr (+)	Dark Green	White
E	Right Rear Spkr (+)	Blue w/ Orange Stripe	Purple
F	Left Rear Spkr (+)	Brown w/ Blue Stripe	Green
G	Power Antenna/Amp	White (use for Infinity Radio)	Blue
H	+12 Volt Battery Wire	Pink or Pink w/ White Stripe	Yellow
I	+12 Volt Ignition Wire	Red w/ White Strip	Red
J	Radio Dimmer Wire	Do Not Use	
K	Headlight Dimmer Wire	Do Not Use	
L	Right Front Spkr (-)	Blue w/ Red Stripe	Gray w/ Black Stripe
M	Left Front Spkr (-)	Brown w/ Red Stripe	White w/ Black Stripe
N	No Wire		
Metal Braid Or Plastic Connector Attached To Back Of Radio Is The Ground Wire			Black (see TIP)

If your original radio had a braided strap bolted to the rear of the radio.

TIP: Crimp a **ring terminal** to the new radios ground wire and insert a bolt through both connectors to connect the ring terminal of the braided ground wire to the ring terminal attached to the new radios ground wire.

If your original radio had a plastic connector containing a single wire plugged into the rear of the radio.

TIP: Crimp a **male tab spade** to the new radios ground wire. Slide it into the female tab spade connector that had originally snapped into the rear of the factory radio.

If your original radio or speaker grills were labeled or marked with 'INFINITY'

TIP: Crimp a **male tab spade** to the new radios ground wire. Slide it into the female tab spade connector that had originally snapped into the rear of the factory radio to activate the 'Infinity' sound system.

Radio Replacement

Document #: 327013

Click on a link
tab to jump to
that page

Cover
Page

Before
You Begin

Remove
& Install

Wire
New Radio

Mount
New Radio

Publication, Duplication, or Retransmission Of This Document Not Expressly Authorized In Writing By The Install Doctor Is Prohibited. Protected By U.S. Copyright Laws. © 1997,1998,1999,2000.

▶ Mounting A Radio To A Dash Kit

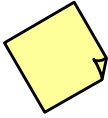

NOTE:

Before you begin: A word about the radio installation kit you are about to install. There are many manufacturers of radio installation kits for this vehicle. Each manufacturer produces slightly different variations of the same kit, and a few make individual kits for specific vehicles. The pictured installation kit shown in the illustrations below is a standard kit used for many Dodge/Chrysler/Plymouth vehicles. Radio installation kits change with the model and years of production of the vehicle. When selecting a kit for this vehicle, make sure the kit you purchase states on the package the installation kit will work with your vehicle model and year. Some kits may require additional setup. Certain kits may be multi function kits designed to work with multiple vehicles and may require the installer to remove break away screw mounting tabs attached to the kit that are not required for your particular vehicle.

All information needed to complete the mounting of the new radio to the installation kit is included on this sheet. If you need additional help, please consult the following tech documents:

Document Title	Document #
Why use radio installation kits	999005
Mounting your radio to an installation kit	999007
Radio security	999010

Follow the instructions below for your type of radio

'DIN' Radios (Rectangular Body Style)

What you need to mount your radio

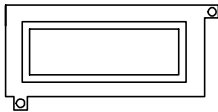

Installation dash kit for 'DIN' (rectangular body style) radios

New Radio

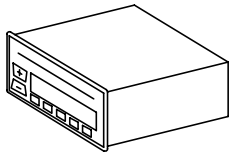

New radios installation sleeve

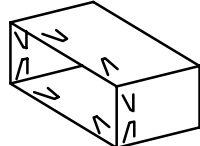

Slide the radios installation sleeve into the mounting kit. (some sleeves may be marked with "TOP" to note the top of the sleeve)

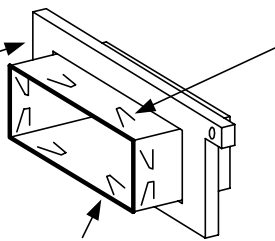

When the installation sleeve is fully inserted and the front edge or lip is seated against the front face of the installation kit, bend the tabs of the installation sleeve behind the rear surface of the installation kit to secure the installation sleeve. Bending the tabs secures the sleeve to the kit.

Front edge or lip of installation sleeve. Slide installation sleeve into the mounting kit until the front edge or lip meets the installation kit.

Radio slides into sleeve after the sleeve is secured to the installation kit

Shafted Radios

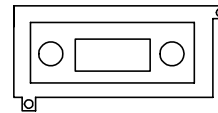

Installation dash kit for shafted style radios

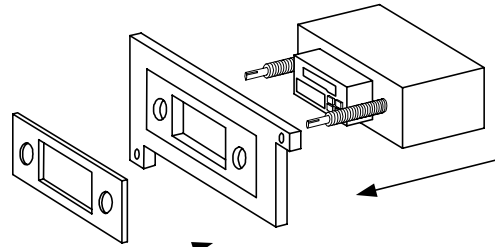

New Radios Face Plate

Slide the radio through the backside of the installation kit. Slide the radios front face plate onto the front surface of the installation kit. Notice how much of the radios shafts are protruding past the front of the kit. You will need to remove the excess by adjusting the depth of the new radios shaft spin nuts. Pull the radio out of the installation kit and spin on the nuts that are included with the radio. Slide the radio back into the installation kit. Adjust the nuts by spinning them forward or back to adjust the depth that the new radios shafts protrude out the front of the kit. To assure a "flush" and professional appearance, make sure that the new radios front face plate is flush with the new radios display box that is visible through the opening of the installation kit. Complete the installation by securing the front face plate with the remaining nuts provided with the new radio. The new radio is secured to the installation kit by "sandwiching" the installation kit between the new radios front face plate and the nuts spun onto the shafts of the radio behind the installation kit.



CAUTION:

Do not overtighten the spin nuts securing the front face plate. Tighten to secure the radio without cracking the plastic.



TIP:

If your radio manufacturer provides 6 spin nuts, use 4 to secure the radio to the installation kit and 2 to secure the front face plate.