

## Factory Radio



## Other Documents Available For This Vehicle:

no documents available at this time

## New Radio

and dash installation kit



## Adobe Acrobat Reader Printing Tips:

- 1) Select "**FILE**" then "**PRINT**" and select your printer.
- 2) In the print options box do the following:
  - A) Locate check box "**Shrink to Fit**". Place check in box.
  - B) Locate box "**Print Quality**". Select highest print dpi allowed by printer.
  - C) If print quality listed is not as high as that printers normal quality, press the "**SETUP..**" button. In the next screen, press the "**PROPERTIES**" button and set the printers print quality to the highest print dpi allowed.

## Document Revision History

01/2000 Document Creation

Click on a link  
tab to jump to  
that page

Cover  
Page

Before  
You Begin

Remove  
& Install

Wire  
New Radio

Mount  
New Radio

Publication, Duplication, or Retransmission Of This Document Not Expressly Authorized In Writing By The Install Doctor Is Prohibited. Protected By U.S. Copyright Laws. © 1997,1998,1999,2000.

### Overview Of This Radio Install

Step	What Section To Go To
Remove old radio from dash	Remove & Install
Wire the new radio	Wire New Radio
Mount the new radio	Mount New Radio
Finishing the installation	Remove & Install

### Parts Needed For This Radio Install

Parts REQUIRED for the install	Description
Dash installation kit	Multi purpose Dodge/Chrysler
Snap on in dash wire harness	Dodge/Chrysler/Plymouth

#### Optional parts for this install

None

### Tools Needed To Complete This Install

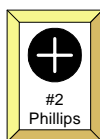

#2  
Phillips



10 mm  
Socket

Hand tools needed  
to remove radio



Solder/  
Crimper

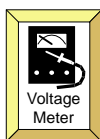

Voltage  
Meter

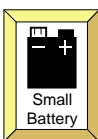

Small  
Battery

Accessory tools needed to test and  
wire the new radio



#### TOOL TIPS:

**Small Battery:** use a battery to test speaker wires. Touching the (+) positive and (-) negative battery leads to a pair of speaker will cause the speaker to make a "Pop" sound indicating that pair of wires goes to that speaker.  
**Voltage Meter:** Always check +12 Volt power wires for voltage before making wire connections. These wires will fluctuate between 10 and 14 Volts.  
**Solder Iron or Crimp Tool:** make wire to wire connections using either a solder iron and electrical tape, OR plastic crimp terminals found at most hardware or auto parts stores.

**PLUS: Wire ties or electrical tape:** to neatly bundle and organize your wires for a professional appearance.

### Installation Difficulty Ratings

**Easy.** No advanced skills or specialty tools needed.

**Basics.** Simple tools required. Installs quickly.

**Intermediate.** Requires knowledge of tools, or disassembly of panels.

**Advanced.** Requires advanced tools, or extra time.

**Difficult.** Involves modifying or cutting of the installation area. Advanced tools and/or skills required. Best if performed by experienced installers.

#### Do It Yourselfers

Basics

#### Professional Installer

Basics

### Support Information If You Need Help

Supplemental information if you need help

Document Title	Document #
Basic DC electronics for automotive applications	999001
Wire splicing: soldering vs. crimping	999004
Why use radio installation kits	999005
Mounting your radio to an installation kit	999007
Why use an OEM snap on wire harness	999008
Wiring your new radio using a wire harness	999009
Testing wires when installing a new radio	999013

## ► Remove Factory Radio

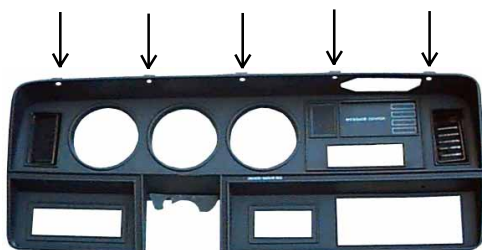

### NOTE:

To remove the radio, the entire plastic dash panel must be removed. There are 5 phillips screws at the top of the dash, and 1 phillips screw located directly above the radio.



### STEP 1:

Locate and remove (5) **phillips screws** securing the top of the dash panel above the instrument display.



### STEP 2:

Locate and remove (1) **phillips screw** located directly above the radio.



### STEP 3:

Once all screws have been removed, the plastic dash panel can be pulled away from the main body of the dash.

Tilt the steering wheel to its lowest position. As seen in the photo above, grab the top corners of the dash panel and pull it forward. The bottom of the dash panel is snapped into place. Pull the dash and lift it above the steering wheel to remove it completely.

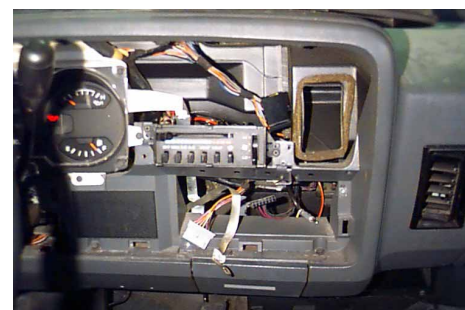

### STEP 4:

The radio should now be visible. The radio is held in with either (2) two **phillips screws** or **10 mm bolts**. Remove both to free the radio. Unplug the antenna wire and (2) two dash wire harness connectors that snap into the rear of the radio. A metal braid ground strap secured to the back of the radio with (1) one **10 mm bolt** must be removed. The radio is now free to be completely removed from the dash.

Click on a link  
tab to jump to  
that page

Cover  
Page

Before  
You Begin

Remove  
& Install

Wire  
New Radio

Mount  
New Radio

Publication, Duplication, or Retransmission Of This Document Not Expressly Authorized In Writing By The Install Doctor Is Prohibited. Protected By U.S. Copyright Laws. © 1997,1998,1999,2000.

## ► Wiring The New Radio

Move to: **Wire New Radio** Section

### Is your radio or speakers marked or labeled with "INFINITY" ?

What about the "Infinity" radio that was originally installed from the factory? What happens to it?

The "Infinity" radio in the vehicle will be removed, but you are going to use the rest of the "Infinity" components still in the vehicle. When you wire the radio, you are going to wire the radio just as you would for a standard radio that would be in this vehicle, but you are going to make one minor change to the new radios ground wire. The new radios ground wire is going to be connected to the plastic connector that had been plugged into the rear of the Infinity radio. This connector is a ground wire to an "Infinity" amplifier which is located away from the radio. When you connect the new radios ground wire to this ground wire for the "Infinity" amplifier, the "Infinity" amplifier will turn on and power the speakers inside the vehicle. In other words, connecting these 2 ground wires together allows you to "integrate" into the "Infinity" amplifier, just as the "Infinity" radio was.

The wiring steps are detailed in the "**Wire New Radio**" section

## ► Mounting The Radio To A Kit

Move to: **Mounting New Radio** Section

## ► Completing The Radio Installation



**STEP 1:**

Attach or plug in all wires into the new radio and plug in the antenna wire. Insert the new radio and installation kit into the dash opening. Secure the radio installation kit with the same (2) two **phillips screws or 10 mm bolts** that had originally secured the auto makers factory radio.



**STEP 2:**

The radio dash panel may now be attached back to the main dash. Replace the (5) five **phillips screws** at the top of the panel and (1) phillips screw located above the radio.

**The installation is now complete.**

Click on a link  
tab to jump to  
that page

Cover  
Page

Before  
You Begin

Remove  
& Install

Wire  
New Radio

Mount  
New Radio

Publication, Duplication, or Retransmission Of This Document Not Expressly Authorized In Writing By The Install Doctor Is Prohibited. Protected By U.S. Copyright Laws. © 1997,1998,1999,2000.

► **Step By Step Wiring**

Auto Makers  
Factory  
Radio

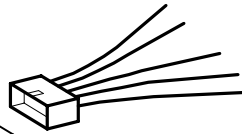
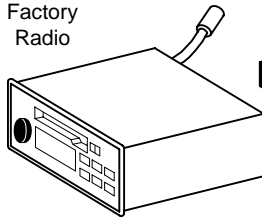

Wire Harness Inside Vehicles  
Dash Which Plugs Into The  
Rear Of The Factory Radio

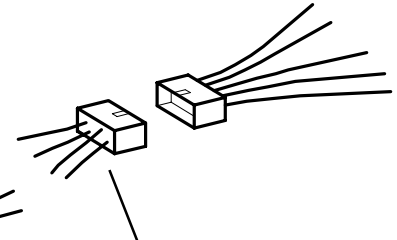
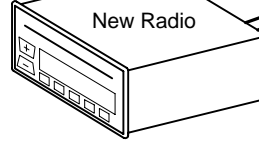

Optional (STRONGLY  
RECOMMENDED) Snap On Wire  
Harness That Splices Into The  
Wires Of The New Radio

(Note: the radio shown is for display purposes and may not be similar in size or dimensions than the auto makers factory radio in your vehicle)

Supplemental information if you need help

Document Title	Document #
Testing wires when installing a new radio	999013
Why use an OEM snap on wire harness	999008
Wiring your new radio using a wire harness	999009
Wire splicing: soldering vs. crimping	999004

**Wiring Instructions:**

The power and speaker wires needed to connect the new radio are attached to the connector of the wire harness located inside the vehicles dash. The Install Doctor **STRONGLY** recommends using an optional snap on wire harness that is specifically designed to snap into the vehicles dash wire harness connector. This will keep you from cutting the vehicles wires. This optional snap on wire harness will have wires on the opposite side of the connector that will allow you to splice these wires to the new radios wires. The only other option is to cut off the vehicles dash wire harness connector and splice the new radios wires directly to these wires. The optional snap on wire harness takes all the guess work out of trying to figure out what each wire is in the vehicles dash wire harness. The optional snap on wire harness tell you what each wire is.

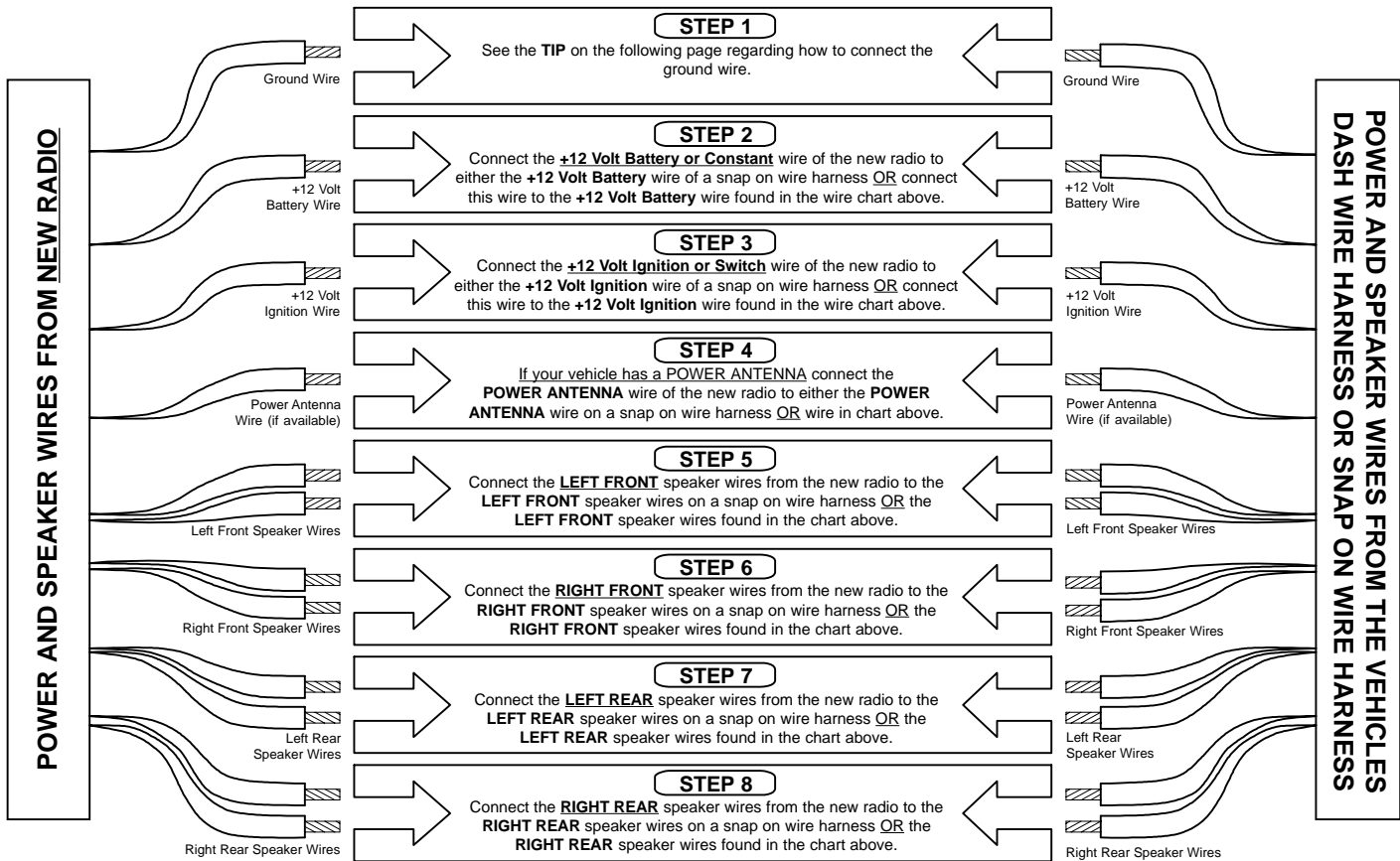

If your radio has the "INFINITY" system, you need to connect the new radios "power antenna wire" or "remote on" wire to PIN G, the power antenna wire, shown in the diagram on the following page.



Cover Page

Before You Begin

Remove & Install

Wire New Radio

Mount New Radio

Publication, Duplication, or Retransmission Of This Document Not Expressly Authorized In Writing By The Install Doctor Is Prohibited. Protected By U.S. Copyright Laws. © 1997,1998,1999,2000.

► Radio Wire & Color Code Information Page 2 of 2

Factory in-dash wire harness (this vehicle has a 2 pc harness) that snaps into the factory radio

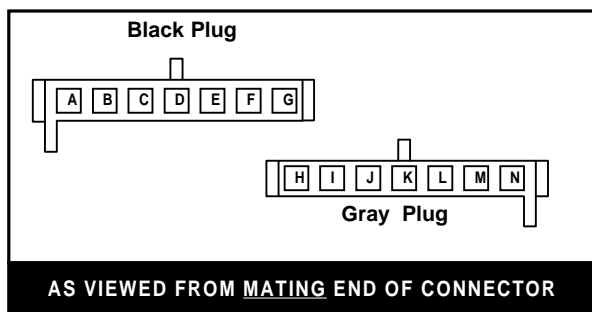

Pin	What It Is	Typical Dodge/Chrysler In Dash Wire Color	Typical New Radio Equivalent Wire Color
A	Right Rear Spkr (-)	Blue w/ White Stripe	Purple w/ Black Stripe
B	Left Rear Spkr (-)	Brown w/ Yellow Stripe	Green w/ Black Stripe
C	Right Front Spkr (+)	Purple	Gray
D	Left Front Spkr (+)	Dark Green	White
E	Right Rear Spkr (+)	Blue w/ Orange Stripe	Purple
F	Left Rear Spkr (+)	Brown w/ Blue Stripe	Green
G	Power Antenna/Amp	White (use for Infinity Radio)	Blue
H	+12 Volt Battery Wire	Pink or Pink w/ White Stripe	Yellow
I	+12 Volt Ignition Wire	Red w/ White Strip	Red
J	Radio Dimmer Wire	Do Not Use	
K	Headlight Dimmer Wire	Do Not Use	
L	Right Front Spkr (-)	Blue w/ Red Stripe	Gray w/ Black Stripe
M	Left Front Spkr (-)	Brown w/ Red Stripe	White w/ Black Stripe
N	No Wire		
Metal Braid Or Plastic Connector Attached To Back Of Radio Is The Ground Wire			Black (see TIP)

If your original radio had a braided strap bolted to the rear of the radio.

**TIP:** Crimp a **ring terminal** to the new radios ground wire and insert a bolt through both connectors to connect the ring terminal of the braided ground wire to the ring terminal attached to the new radios ground wire.

If your original radio had a plastic connector containing a single wire plugged into the rear of the radio.

**TIP:** Crimp a **male tab spade** to the new radios ground wire. Slide it into the female tab spade connector that had originally snapped into the rear of the factory radio.

If your original radio or speaker grills were labeled or marked with 'INFINITY'

**TIP:** Crimp a **male tab spade** to the new radios ground wire. Slide it into the female tab spade connector that had originally snapped into the rear of the factory radio to activate the 'Infinity' sound system.

If your radio has the "INFINITY" system, you need to connect the new radios "power antenna wire" or "remote on" wire to PIN G, the power antenna wire, shown in the diagram above.

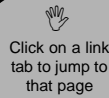

Cover Page

Before You Begin

Remove & Install

Wire New Radio

Mount New Radio

Publication, Duplication, or Retransmission Of This Document Not Expressly Authorized In Writing By The Install Doctor Is Prohibited. Protected By U.S. Copyright Laws. © 1997,1998,1999,2000.

► **Mounting A Radio To A Dash Kit**

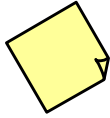

**NOTE:**

**Before you begin:** A word about the radio installation kit you are about to install. There are many manufacturers of radio installation kits for this vehicle. Each manufacturer produces slightly different variations of the same kit, and a few make individual kits for specific vehicles. The pictured installation kit shown in the illustrations below is a standard kit used for many Dodge/Chrysler/Plymouth vehicles. Radio installation kits change with the model and years of production of the vehicle. When selecting a kit for this vehicle, make sure the kit you purchase states on the package the installation kit will work with your vehicle model and year. Some kits may require additional setup. Certain kits may be multi function kits designed to work with multiple vehicles and may require the installer to remove break away screw mounting tabs attached to the kit that are not required for your particular vehicle.

All information needed to complete the mounting of the new radio to the installation kit is included on this sheet. If you need additional help, please consult the following tech documents:

Document Title	Document #
Why use radio installation kits	999005
Mounting your radio to an installation kit	999007
Radio security	999010

**Follow the instructions below for your type of radio**

**'DIN' Radios (Rectangular Body Style)**

**What you need to mount your radio**

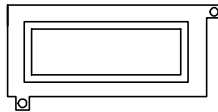

Installation dash kit for 'DIN' (rectangular body style) radios

New Radio

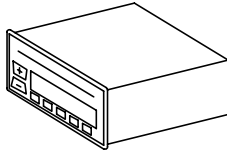

New radios installation sleeve

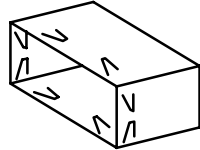

Slide the radios installation sleeve into the mounting kit. (some sleeves may be marked with "TOP" to note the top of the sleeve)

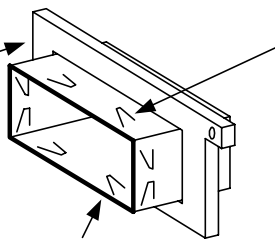

When the installation sleeve is fully inserted and the front edge or lip is seated against the front face of the installation kit, bend the tabs of the installation sleeve behind the rear surface of the installation kit to secure the installation sleeve. Bending the tabs secures the sleeve to the kit.

Front edge or lip of installation sleeve. Slide installation sleeve into the mounting kit until the front edge or lip meets the installation kit.

**Radio slides into sleeve after the sleeve is secured to the installation kit**

**Shafted Radios**

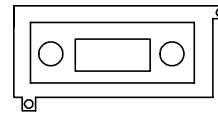

Installation dash kit for shafted style radios

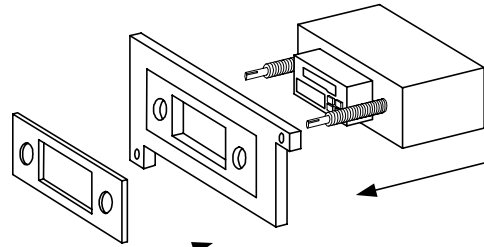

New Radios Face Plate

Slide the radio through the backside of the installation kit. Slide the radios front face plate onto the front surface of the installation kit. Notice how much of the radios shafts are protruding past the front of the kit. You will need to remove the excess by adjusting the depth of the new radios shaft spin nuts. Pull the radio out of the installation kit and spin on the nuts that are included with the radio. Slide the radio back into the installation kit. Adjust the nuts by spinning them forward or back to adjust the depth that the new radios shafts protrude out the front of the kit. To assure a "flush" and professional appearance, make sure that the new radios front face plate is flush with the new radios display box that is visible through the opening of the installation kit. Complete the installation by securing the front face plate with the remaining nuts provided with the new radio. The new radio is secured to the installation kit by "sandwiching" the installation kit between the new radios front face plate and the nuts spun onto the shafts of the radio behind the installation kit.



**CAUTION:**

Do not overtighten the spin nuts securing the front face plate. Tighten to secure the radio without cracking the plastic.



**TIP:**

If your radio manufacturer provides 6 spin nuts, use 4 to secure the radio to the installation kit and 2 to secure the front face plate.