

# Ram Truck - 1500/2500/3500

Dodge/Chrysler/Plymouth

Radio Replacement

Document #: 327025

1994

thru 1996

Click on a link  
tab to jump to  
that page

Cover  
Page

Before  
You Begin

Remove  
& Install

Wire  
New Radio

Mount  
New Radio

Publication, Duplication, or Retransmission Of This Document Not Expressly Authorized In Writing By The Install Doctor Is Prohibited. Protected By U.S. Copyright Laws. © 1997,1998,1999,2000.

## Factory Radio



## New Radio

and dash installation kit



## Other Documents Available For This Vehicle:

No other documents available at this time

## Adobe Acrobat Reader Printing Tips:

- 1) Select "**FILE**" then "**PRINT**" and select your printer.
- 2) In the print options box do the following:
  - A) Locate check box "**Shrink to Fit**". Place check in box.
  - B) Locate box "**Print Quality**". Select highest print dpi allowed by printer.
  - C) If print quality listed is not as high as that printers normal quality, press the "**SETUP..**" button. In the next screen, press the "**PROPERTIES**" button and set the printers print quality to the highest print dpi allowed.

## Document Revision History

02/2000 Document Creation

Click on a link  
tab to jump to  
that page

Cover  
Page

Before  
You Begin

Remove  
& Install

Wire  
New Radio

Mount  
New Radio

Publication, Duplication, or Retransmission Of This Document Not Expressly Authorized In Writing By The Install Doctor Is Prohibited. Protected By U.S. Copyright Laws. © 1997,1998,1999,2000.

## Overview Of This Radio Install

Step	What Section To Go To
Remove old radio from dash	Remove & Install
Wire the new radio	Wire New Radio
Mount the new radio	Mount New Radio
Finishing the installation	Step By Step

## Parts Needed For This Radio Install

Parts REQUIRED for the install	Description
Dash installation kit	Multi purpose Dodge/Chrysler
Snap on wire harness adapter	Dodge/Chrysler/Plymouth 2 pc.

### Optional parts for this install

None

## Tools Needed To Complete This Install

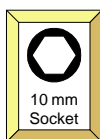

10 mm  
Socket

Hand tools needed  
to remove radio



Solder/  
Crimper

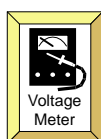

Voltage  
Meter

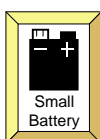

Small  
Battery

Accessory tools needed to test and  
wire the new radio

### ! TOOL TIPS:

**Small Battery:** use a battery to test speaker wires. Touching the (+) positive and (-) negative battery leads to a pair of speaker will cause the speaker to make a "Pop" sound indicating that pair of wires goes to that speaker.  
**Voltage Meter:** Always check +12 Volt power wires for voltage before making wire connections. These wires will fluctuate between 10 and 14 Volts.  
**Solder Iron or Crimp Tool:** make wire to wire connections using either a solder iron and electrical tape, OR plastic crimp terminals found at most hardware or auto parts stores.

**PLUS: Wire ties or electrical tape:** to neatly bundle and organize your wires for a professional appearance.

## Installation Difficulty Ratings

**Easy.** No advanced skills or specialty tools needed.

**Basics.** Simple tools required. Installs quickly.

**Intermediate.** Requires knowledge of tools, or disassembly of panels.

**Advanced.** Requires advanced tools, or extra time.

**Difficult.** Involves modifying or cutting of the installation area. Advanced tools and/or skills required. Best if performed by experienced installers.

### Do It Yourselfers

Basics

### Professional Installer

Basics

## Support Information If You Need Help

Supplemental information if you need help

Document Title	Document #
Basic DC electronics for automotive applications	999001
Wire splicing: soldering vs. crimping	999004
Why use radio installation kits	999005
Mounting your radio to an installation kit	999007
Why use an OEM snap on wire harness	999008
Wiring your new radio using a wire harness	999009
Testing wires when installing a new radio	999013

## ▶ Remove Factory Radio



### STEP 1:

To remove the radio, the entire plastic dash panel surrounding the radio and dash instruments must be removed.

Pull out the ashtray. Locate and remove two (2) phillips screws securing the ashtray bracket. Pull out the ashtray bracket and set it aside.



### STEP 2:

Open the drink tray. Locate and remove two (2) phillips screws hidden behind the front panel of the drink tray. Once the screws are removed, pull out the entire drink tray assembly and set it aside.



### STEP 3:

Once the screws securing the ashtray bracket and drink tray assembly have been removed, the entire dash panel can be removed.

The dash panel simply unsnaps from the dash. Start at the top of the dash at one corner and pull gently until the dash separates from the body of the main dash.

Publication, Duplication, or Retransmission Of This Document Not Expressly Authorized In Writing By The Install Doctor Is Prohibited. Protected By U.S. Copyright Laws. © 1997,1998,1999,2000.



#### STEP 4:

The radio is secured to the dash with two (2) 10mm bolts. Locate and remove both.



#### STEP 5:

Pull the radio out of the dash. Unplug the black cable plugged into the rear of the radio. Unplug two plastic wire harness connectors (1 black, 1 gray) snapped into the rear of the radio. Some years of this vehicle have a metal braid bolted to the rear of the radio. Remove the braid by removing the 10mm bolts that secures it to the rear of the radio.

### ► Wiring The New Radio

Move to: [Wire New Radio](#) Section

### ► Mounting The Radio To A Kit

Move to: [Mount New Radio](#) Section

### ► Completing The Radio Installation



#### STEP 1:

Insert the radio/kit assembly into the opening in the dash.

Plug in the antenna cable into the rear of the new radio. Make sure all wire connections to the new radio have been completed and connect any connectors into the rear of the new radio.

Secure the kit into the dash with the same two 10mm bolts that had originally secured the factory radio.



#### STEP 2:

Reattach the plastic dash panel back onto the main body of the dash.

**The installation is now complete.**

# Ram Truck - 1500/2500/3500

Dodge/Chrysler/Plymouth

Radio Replacement  
Document #: 327025

1994  
thru 1996

Click on a link  
tab to jump to  
that page

Cover  
Page

Before  
You Begin

Remove  
& Install

Wire  
New Radio

Mount  
New Radio

Publication, Duplication, or Retransmission Of This Document Not Expressly Authorized In Writing By The Install Doctor Is Prohibited. Protected By U.S. Copyright Laws. © 1997,1998,1999,2000.

## Step By Step Wiring

Page 1 of 2

Auto Makers  
Factory  
Radio

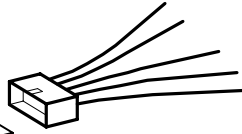
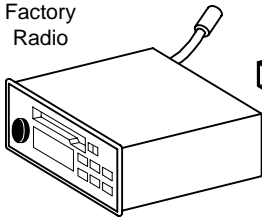

Wire Harness Inside Vehicles  
Dash Which Plugs Into The  
Rear Of The Factory Radio

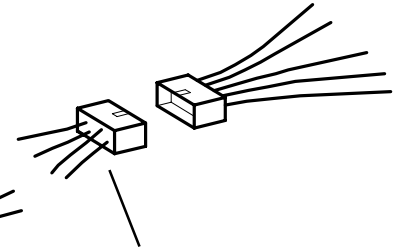
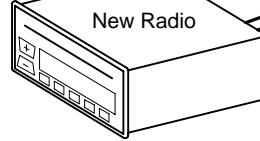

Optional Snap On Wire Harness  
(Strongly Recommended)  
That Splices Into The Wires Of  
The New Radio

(Note: the radio shown is for display purposes and may not be similar in size or dimensions than the auto makers factory radio in your vehicle)

Supplemental information if you need help

Document Title	Document #
Testing wires when installing a new radio	999013
Why use an OEM snap on wire harness	999008
Wiring your new radio using a wire harness	999009
Wire splicing: soldering vs. crimping	999004

## Wiring Instructions:

The power and speaker wires needed to connect the new radio are attached to the connector of the wire harness located inside the vehicles dash. The Install Doctor **STRONGLY** recommends using an optional snap on wire harness that is specifically designed to snap into the vehicles dash wire harness connector. This will keep you from cutting the vehicles wires. This optional snap on wire harness will have wires on the opposite side of the connector that will allow you to splice these wires to the new radios wires. The only other option is to cut off the vehicles dash wire harness connector and splice the new radios wires directly to these wires. The optional snap on wire harness takes all the guess work out of trying to figure out what each wire is in the vehicles dash wire harness. The optional snap on wire harness tell you what each wire is.

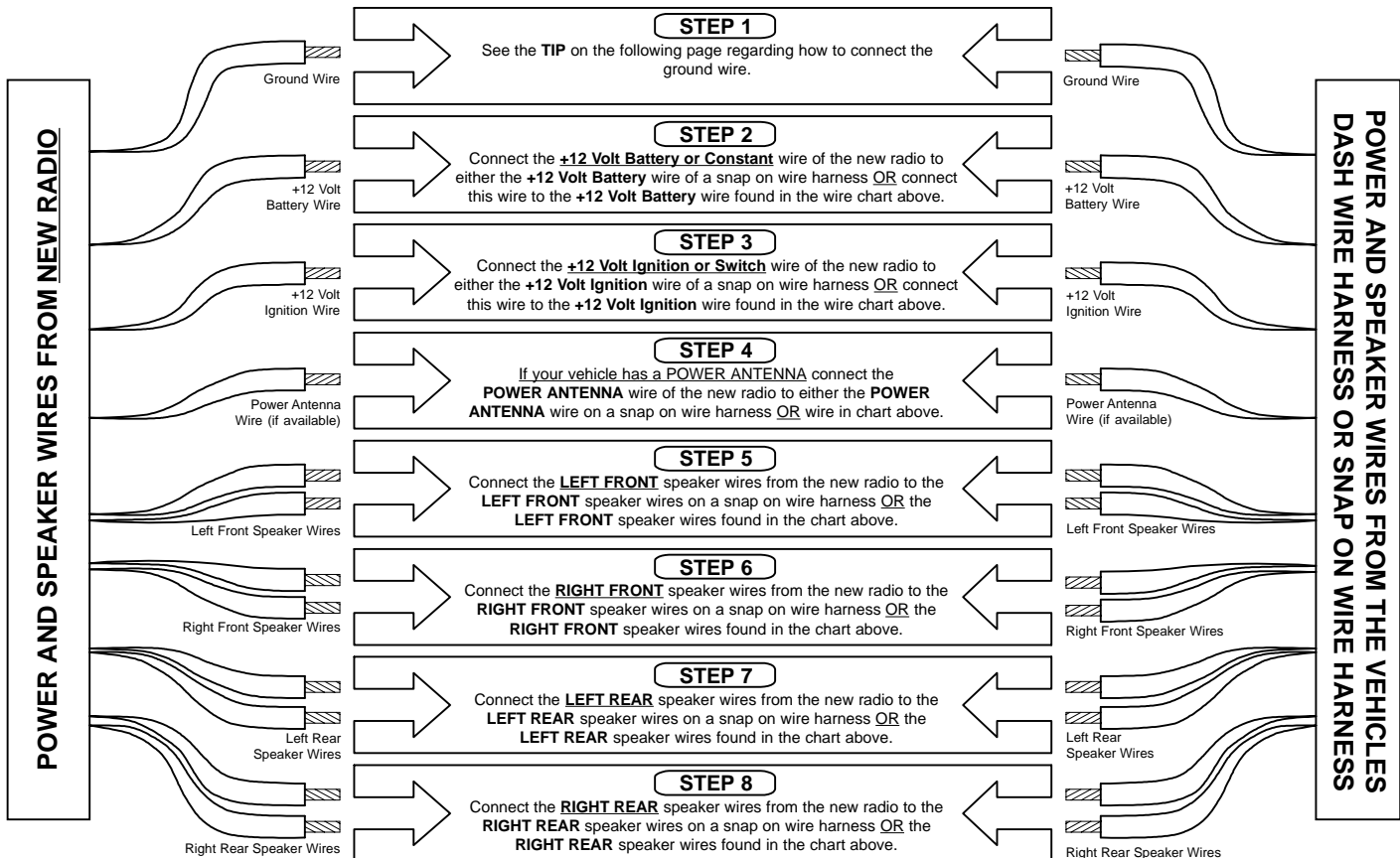



Cover Page

Before You Begin

Remove & Install

Wire New Radio

Mount New Radio

Publication, Duplication, or Retransmission Of This Document Not Expressly Authorized In Writing By The Install Doctor Is Prohibited. Protected By U.S. Copyright Laws. © 1997,1998,1999,2000.

## ▶ Radio Wire & Color Code Information

Page 2 of 2

Factory in-dash wire harness (this vehicle has a 2 pc harness) that snaps into the factory radio

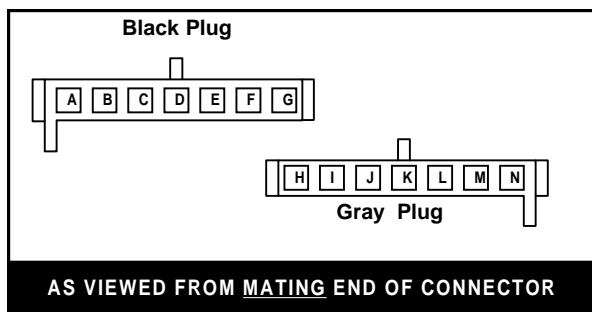

Pin	What It Is	Typical Dodge/Chrysler In Dash Wire Color	Typical New Radio Equivalent Wire Color
A	Right Rear Spkr (-)	Blue w/ White Stripe	Purple w/ Black Stripe
B	Left Rear Spkr (-)	Brown w/ Yellow Stripe	Green w/ Black Stripe
C	Right Front Spkr (+)	Purple	Gray
D	Left Front Spkr (+)	Dark Green	White
E	Right Rear Spkr (+)	Blue w/ Orange Stripe	Purple
F	Left Rear Spkr (+)	Brown w/ Blue Stripe	Green
G	Power Antenna/Amp	White (use for Infinity Radio)	Blue
H	+12 Volt Battery Wire	Pink or Pink w/ White Stripe	Yellow
I	+12 Volt Ignition Wire	Red w/ White Strip	Red
J	Radio Dimmer Wire	Do Not Use	
K	Headlight Dimmer Wire	Do Not Use	
L	Right Front Spkr (-)	Blue w/ Red Stripe	Gray w/ Black Stripe
M	Left Front Spkr (-)	Brown w/ Red Stripe	White w/ Black Stripe
N	No Wire		
Metal Braid Or Plastic Connector Attached To Back Of Radio Is The Ground Wire			Black (see TIP)

If your original radio had a braided strap bolted to the rear of the radio.

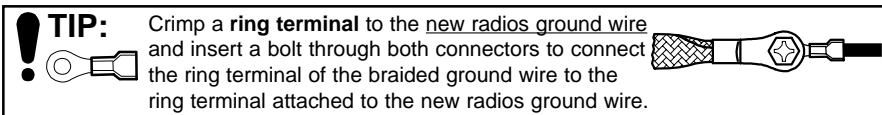

If your original radio had a plastic connector containing a single wire plugged into the rear of the radio.

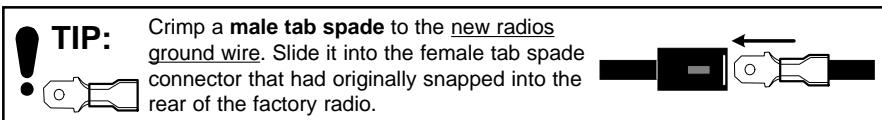

If your original radio or speaker grills were labeled or marked with 'INFINITY'

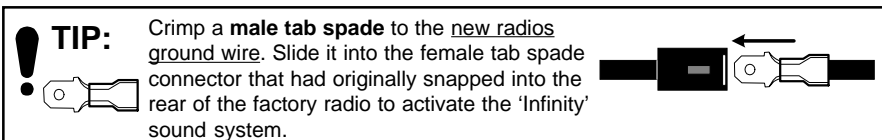



Cover Page

Before You Begin

Remove & Install

Wire New Radio

Mount New Radio

Publication, Duplication, or Retransmission Of This Document Not Expressly Authorized In Writing By The Install Doctor Is Prohibited. Protected By U.S. Copyright Laws. © 1997,1998,1999,2000.

## ▶ Mounting A Radio To A Dash Kit

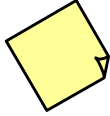

### NOTE:

**Before you begin:** A word about the radio installation kit you are about to install. There are many manufacturers of radio installation kits for this vehicle.

Each manufacturer produces slightly different variations of the same kit, and a few make individual kits for specific vehicles. The pictured installation kit shown in the illustrations below is a standard kit used for many Dodge/Chrysler/Plymouth vehicles. Radio installation kits change with the model and years of production of the vehicle. When selecting a kit for this vehicle, make sure the kit you purchase states on the package the installation kit will work with your vehicle model and year. Some kits may require additional setup. Certain kits may be multi function kits designed to work with multiple vehicles and may require the installer to remove break away screw mounting tabs attached to the kit that are not required for your particular vehicle.

All information needed to complete the mounting of the new radio to the installation kit is included on this sheet. If you need additional help, please consult the following tech documents:

Document Title	Document #
Why use radio installation kits	999005
Mounting your radio to an installation kit	999007
Radio security	999010

### Follow the instructions below for your type of radio

#### 'DIN' Radios (Rectangular Body Style)

##### What you need to mount your radio

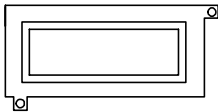

Installation dash kit for 'DIN' (rectangular body style) radios

New Radio

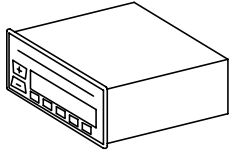

New radios installation sleeve

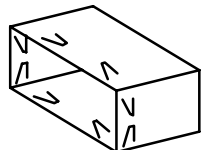

Slide the radios installation sleeve into the mounting kit. (some sleeves may be marked with "TOP" to note the top of the sleeve)

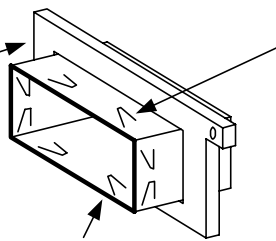

When the installation sleeve is fully inserted and the front edge or lip is seated against the front face of the installation kit, bend the tabs of the installation sleeve behind the rear surface of the installation kit to secure the installation sleeve. Bending the tabs secures the sleeve to the kit.

Front edge or lip of installation sleeve. Slide installation sleeve into the mounting kit until the front edge or lip meets the installation kit.

**Radio slides into sleeve after the sleeve is secured to the installation kit**

#### Shafted Radios

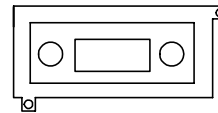

Installation dash kit for shafted style radios

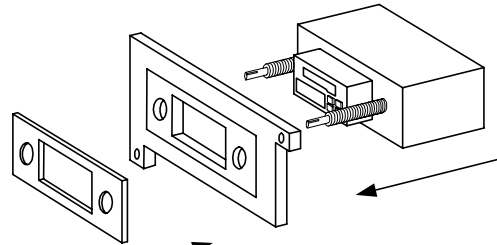

New Radios Face Plate

Slide the radio through the backside of the installation kit. Slide the radios front face plate onto the front surface of the installation kit. Notice how much of the radios shafts are protruding past the front of the kit. You will need to remove the excess by adjusting the depth of the new radios shaft spin nuts. Pull the radio out of the installation kit and spin on the nuts that are included with the radio. Slide the radio back into the installation kit. Adjust the nuts by spinning them forward or back to adjust the depth that the new radios shafts protrude out the front of the kit. To assure a "flush" and professional appearance, make sure that the new radios front face plate is flush with the new radios display box that is visible through the opening of the installation kit. Complete the installation by securing the front face plate with the remaining nuts provided with the new radio. The new radio is secured to the installation kit by "sandwiching" the installation kit between the new radios front face plate and the nuts spun onto the shafts of the radio behind the installation kit.



### CAUTION:

Do not overtighten the spin nuts securing the front face plate. Tighten to secure the radio without cracking the plastic.



### TIP:

If your radio manufacturer provides 6 spin nuts, use 4 to secure the radio to the installation kit and 2 to secure the front face plate.