

## Factory Radio



## New Radio and radio installation kit



## Other Documents Available For This Vehicle:

No additional documents available at this time

## Adobe Acrobat Reader Printing Tips:

- 1) Select "**FILE**" then "**PRINT**" and select your printer.
- 2) In the print options box do the following:
  - A) Locate check box "**Shrink to Fit**". Place check in box.
  - B) Locate box "**Print Quality**". Select highest print dpi allowed by printer.
  - C) If print quality listed is not as high as that printers normal quality, press the "**SETUP..**" button. In the next screen, press the "**PROPERTIES**" button and set the printers print quality to the highest print dpi allowed.

## Document Revision History

01/2000 Document Creation



Cover  
Page

Before  
You Begin

Remove  
& Install

Wire  
New Radio

Mount  
New Radio

Publication, Duplication, or Retransmission Of This Document Not Expressly Authorized In Writing By The Install Doctor Is Prohibited. Protected By U.S. Copyright Laws. © 1997,1998,1999,2000.

## Overview Of This Radio Install

Step	What Section To Go To
Remove old radio from dash	Remove & Install
Wire the new radio	Wire New Radio
Mount the new radio	Mount New Radio
Finishing the installation	Remove & Install

## Parts Needed For This Radio Install

Parts REQUIRED for the install	Description
Snap on in dash wire harness	** Please read instructions first
Radio dash installation kit	Ford Explorer/Ranger kit

### Optional parts for this install

None

## Tools Needed To Complete This Install

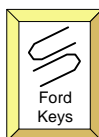

OR  
Coat Hanger

Hand tools needed  
to remove radio

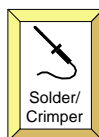

Solder/  
Crimper

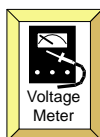

Voltage  
Meter

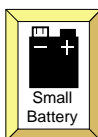

Small  
Battery

Accessory tools needed to test and  
wire the new radio



### TOOL TIPS:

**Small Battery:** use a battery to test speaker wires. Touching the (+) positive and (-) negative battery leads to a pair of speaker will cause the speaker to make a "Pop" sound indicating that pair of wires goes to that speaker.  
**Voltage Meter:** Always check +12 Volt power wires for voltage before making wire connections. These wires will fluctuate between 10 and 14 Volts.  
**Solder Iron or Crimp Tool:** make wire to wire connections using either a solder iron and electrical tape, OR plastic crimp terminals found at most hardware or auto parts stores.

**PLUS: Wire ties or electrical tape:** to neatly bundle and organize your wires for a professional appearance.

## Installation Difficulty Ratings

**Easy.** No advanced skills or specialty tools needed.

**Basics.** Simple tools required. Installs quickly.

**Intermediate.** Requires knowledge of tools, or disassembly of panels.

**Advanced.** Requires advanced tools, or extra time.

**Difficult.** Involves modifying or cutting of the installation area. Advanced tools and/or skills required. Best if performed by experienced installers.

### Do It Yourselfers

Basics

### Professional Installer

Basics

## Support Information If You Need Help

Supplemental information if you need help

Document Title	Document #
Basic DC electronics for automotive applications	999001
Wire splicing: soldering vs. crimping	999004
Why use radio installation kits	999005
Mounting your radio to an installation kit	999007
Why use an optional snap on wire harness	999008
Wiring your new radio using a wire harness	999009
Testing wires when installing a new radio	999013

## ► Remove Factory Radio



**STEP 1:**

The Ford radio is snapped into the vehicles dash. With the proper tool, known as Ford radio removal keys, the Ford radio can be pulled forward out of the dash. A clothes hanger can be used instead of actual Ford radio removal keys. Cut the clothes hanger and bend 2 pieces in a 'U' shape.

For more information on how to remove the radio, see the diagram below.



**STEP 2:**

Pull the radio from the dash. Unplug the antenna cable from the rear of the radio. Unplug the wire harness connector from the rear of the radio. (Ford Excursions may have a Ford amplifier in the vehicle. This is the step you will be able to tell)

## Removing Ford Radios Using "U" Shaped Removal Keys

Insert the "U" shaped keys into the holes as shown in the diagram. Coat hangers can be cut and bent into shape for a quick, cheap replacement or alternative when Ford keys are not available.

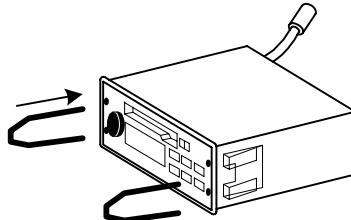

In order for the radio to be removed, clips attached to the side of the radio must be moved inward so the radio can slide out of the dash. Insert the keys and push each key out, away from the radio. The ends of the keys will press into the clips. While pushing the keys outward, pull and the radio should slide forward out of the dash.

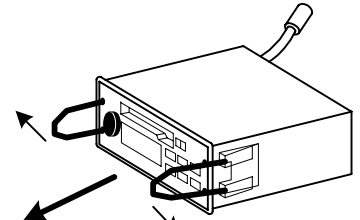

## ► Wiring The New Radio

Move to: [Wire New Radio](#) Section

Your Ford may have the Ford Premium Sound System installed in it from the factory. This means the speakers in the vehicle are actually powered by a Ford amplifier instead of the amplifier inside the radio (the amp is located away from the radios dash location). The "**Wire New Radio**" section will detail wiring for both standard Ford radios and the wiring for Premium Sound System radios. The only way to tell the difference between a standard Ford radio and the Ford Premium Sound System is to pull the radio and look at the wire harness connectors plugged into the rear of the Ford factory radio. You will be able to see the 2 different sets of wire harnesses in the "**Wire New Radio**" section.

## ► Mounting The Radio

Move to: [Mounting New Radio](#) Section

## ▶ Completing The Radio Installation



### STEP 1:

Attach the radio installation kit to the dash, without the radio attached to the kit.

**TIP:** snap the kit into the opening in the dash before mounting the radio to the kit. If the kit is attached to the kit before the kit is installed in the dash, the snaps that secure the kit to the dash may not properly snap into the dash.

Snapping the kit into the dash without the radio will ensure that the kit snaps properly into the dash.



### STEP 2:

Plug the antenna cable into the new radio. Make sure all power and speaker wires for the new radio have been properly connected and plug in any connectors to the rear of the new radio. Slide the radio into the kit.

**The Installation Is Now Complete**

Publication, Duplication, or Retransmission Of This Document Not Expressly Authorized In Writing By The Install Doctor Is Prohibited. Protected By U.S. Copyright Laws. © 1997,1998,1999,2000.

► **Step By Step Wiring**

Auto Makers  
Factory  
Radio

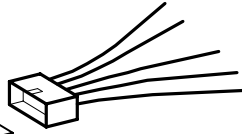
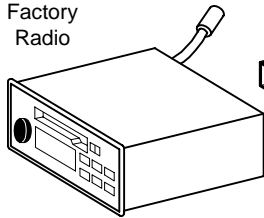

Wire Harness Inside Vehicles  
Dash Which Plugs Into The  
Rear Of The Factory Radio

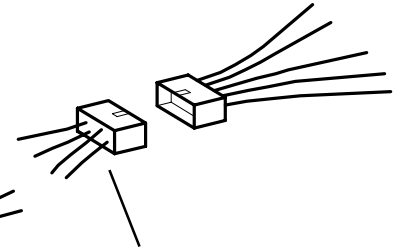
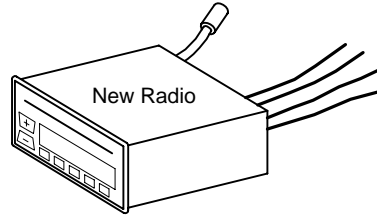

Optional (STRONGLY  
RECOMMENDED) Snap On Wire  
Harness That Splices Into The  
Wires Of The New Radio

(Note: the radio shown is for display purposes and may not be similar in size or dimensions than the auto makers factory radio in your vehicle)

Supplemental information if you need help

Document Title	Document #
Testing wires when installing a new radio	999013
Why use an OEM snap on wire harness	999008
Wiring your new radio using a wire harness	999009
Wire splicing: soldering vs. crimping	999004

**Wiring Instructions:**

The power and speaker wires needed to connect the new radio are attached to the connector of the wire harness located inside the vehicles dash. The Install Doctor **STRONGLY** recommends using an optional snap on wire harness that is specifically designed to snap into the vehicles dash wire harness connector. This will keep you from cutting the vehicles wires. This optional snap on wire harness will have wires on the opposite side of the connector that will allow you to splice these wires to the new radios wires. The only other option is to cut off the vehicles dash wire harness connector and splice the new radios wires directly to these wires. The optional snap on wire harness takes all the guess work out of trying to figure out what each wire is in the vehicles dash wire harness. The optional snap on wire harness tell you what each wire is.

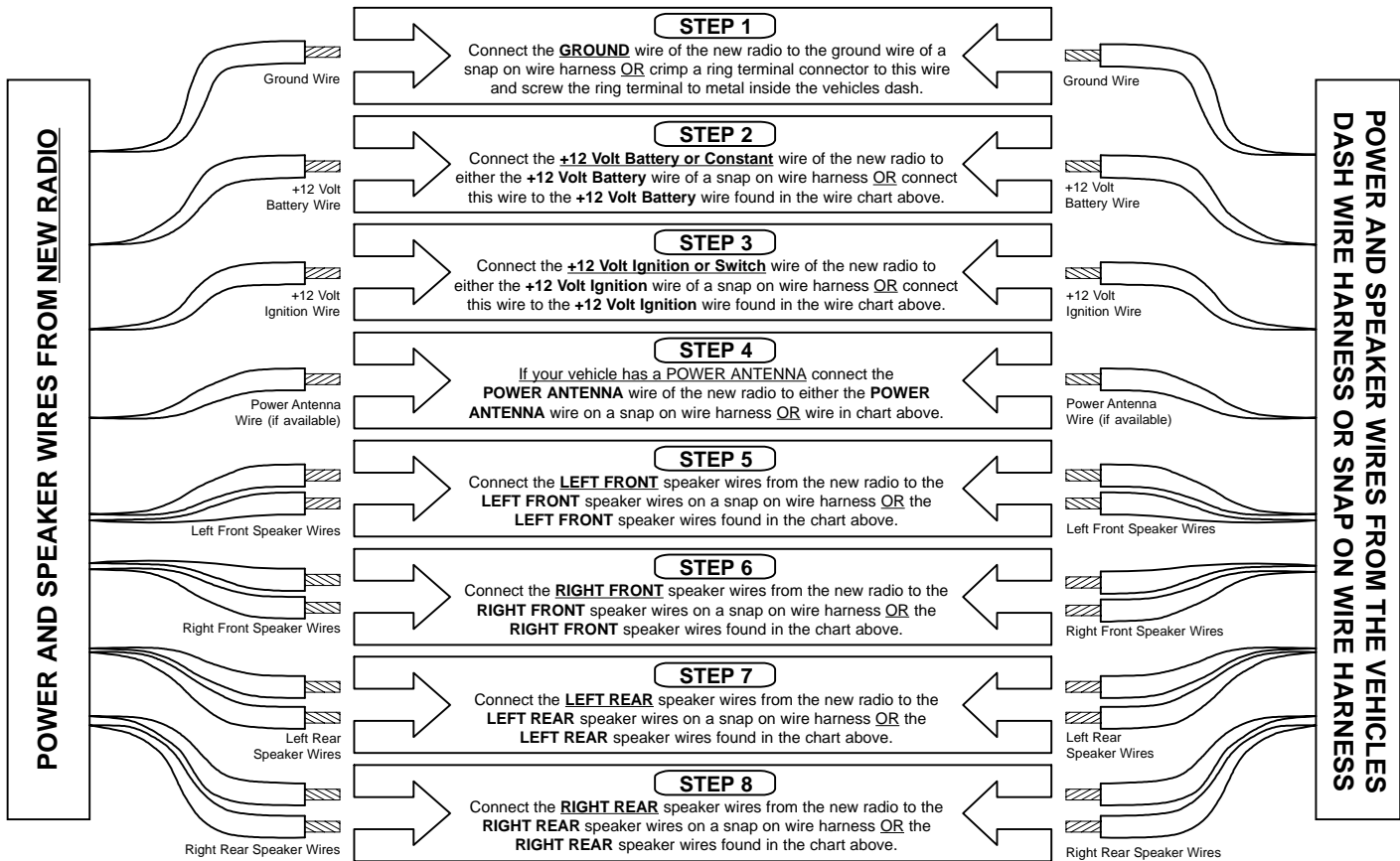



## ▶ Radio Wire & Color Code Information

Page 2 of 3

### If Your Vehicle Has A Ford Premium Sound System Radio (Some Explorers)

This vehicle uses has a 2 pc wire harness. The black connector is the input to the vehicles separate amplifier. The second plug contains all necessary power wires.

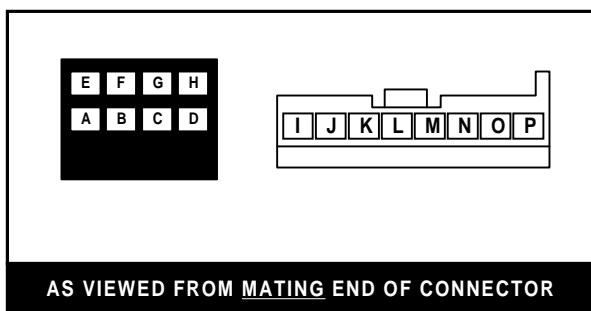

#### DO NOT CUT THE WIRES OF THE BLACK CONNECTOR

The Install Doctor **STRONGLY** recommends using a snap on “integration” wire harness which will safely and easily allow you to connect a new radio to the existing wires of the Ford radio system.

The “integration” wire harness will have all necessary wires correctly labeled. This allows you to follow the instructions on the previous page.

The Ford radio in your vehicle uses a separate Ford amplifier that powers the speakers instead of the Ford radio powering the speakers. This creates problems when installing a new replacement radio into the vehicle. At the radio, the wire harness inside the dash would normally have all necessary speaker and power wires to install the new radio. However, the speaker wires needed to install the new radio are plugged into the Ford Premium Sound System amplifier which is located away from the radio.

There are (3) options when installing a new radio you need to consider before installing your new radio, one of which is not recommended and requires extensive rewiring of every speaker in the vehicle.

**Option 1:** you can choose to “integrate” into the Ford amplifier. This is the simplest and easiest installation and for the majority of new replacement radios this is the BEST option. A Ford Integration Wire Harness is needed. This wire harness is very similar to a standard Ford radio snap on wire harness used to install radios in Ford vehicles with standard radios but the harness will have a small box attached to it which will allow you to splice the new radios speaker wires directly to the wires of the integration harness. Inside this box is electronics which will convert the new radios speaker wire outputs into the necessary low voltage signal to run the Ford amplifier. This means that the speakers in the vehicle are being powered by the Ford amplifier, not the amplifier inside the new radio. **The information on this sheet is structured to use OPTION 1 to integrate into the original Ford amplifier. This has become the most accepted method of installing a new replacement radio in this type of Ford vehicle with the Premium Sound System.**

**Option 2:** you can also choose to “bypass” the Ford amplifier in the vehicle and choose to power the speakers in the vehicle with the amplifier inside the new radio instead of the Ford amplifier. This is a 2 step process. You still have to wire the new radio at the dash, and you have to find the amplifier in the vehicle and add a jumper cable (included with the bypass wire harness) to the amplifier; unplugging the inputs and outputs of the amplifier and connecting them together with the jumper from the bypass wire harness. This method is only used for radios with more than 40 watts per channel output.

**Option 3:** or you can choose to completely run new speaker wire directly from the new radio to each speaker. However, this is NOT recommended.

**Radio Wire & Color Code Information** Page 3 of 3

**If Your Vehicle Has A Standard Ford Radio**

This vehicle uses has a 2 pc wire harness.

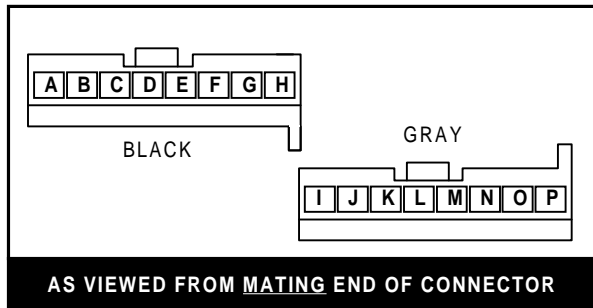

**Ford Wire Harnesses  
Up To 1998-1999 Production Models**

Pin	What It Is	Typical Ford In Dash Wire Color	"Typical" New Radio Equivalent Wire Color
A	Right Rear Spkr (-)	Blue	Purple w/ Black Stripe
B	Right Rear Spkr (+)	White w/ Blue Stripe	Purple
C	Right Front Spkr (-)	White	Gray w/ Black Stripe
D	Right Front Spkr (+)	Blue w/ White Stripe	Gray
E	Left Rear Spkr (-)	Red w/ Blue Stripe	Green w/ Black Stripe
F	Left Rear Spkr (+)	White w/ Blue Stripe	Green
G	Left Front Spkr (-)	Blue w/ Orange Stripe	White w/ Black Stripe
H	Left Front Spkr (+)	Purple	White
I	Amplifier Turn On	<b>Do Not Use For This Vehicle</b>	
J	Power Antenna Turn On	<b>Do Not Use For This Vehicle</b>	
K	Ground Wire		Black
L		<b>Do Not Use For This Vehicle</b>	
M	Dash Light Dimmer Wire		Orange (if available)
N	+12 Volt Ignition Wire		Red
O		<b>Do Not Use For This Vehicle</b>	
P	+12 Volt Battery Wire		Yellow

**Note:** using an optional snap on wire harness adapter will simplify the wiring. Most snap on wire harness adapters have already converted and color coded the wires from the auto makers in dash wire harness to match typical aftermarket radio wire colors.

\*\* The wire colors listed in the chart above are typical for Ford vehicles during these years but may not be the exact colors for this vehicle. This is another reason to use a snap on wire harness adapter. \*\*

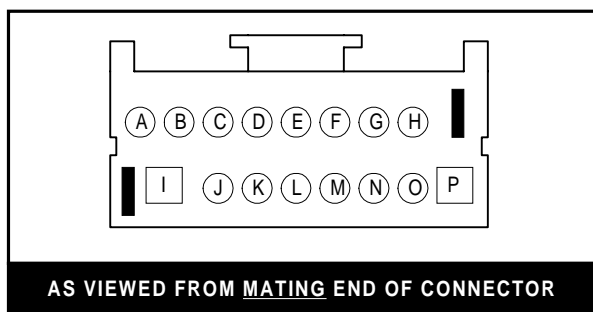

**Ford Wire Harnesses  
1998-1999 And Newer Production  
Models**

Pin	What It Is	Typical GM Factory In Dash Wire Color	Typical New Radio Equivalent Wire Color
A	Right Front Spkr (-)	Green w/ Orange Stripe	Gray w/ Black Stripe
B	Right Front Spkr (+)	Lite Tan w/ Green Stripe	Gray
C	Right Rear Spkr (-)	Orange w/ Maroon Stripe	Purple w/ Black Stripe
D	Right Rear Spkr (+)	Black w/ Purple Stripe	Purple
E		<b>Do Not Use</b>	
F		<b>Do Not Use</b>	
G		<b>Do Not Use</b>	
H	Dash Light Dimmer Wire		Orange
I	Ford Amplifier Ground Wire		
J	Left Front Spkr (-)	Lite Blue w/ White Stripe	White w/ Black Stripe
K	Left Front Spkr (+)	Orange w/ Green Stripe	White
L	Left Rear Spkr (-)	Brown w/ Yellow Stripe	Green w/ Black Stripe
M	Left Rear Spkr (+)	Gray w/ Lite Blue Stripe	Green
N	Ground Wire	Black w/ Green Stripe	Black
O	+12 Volt Ignition Wire	Black w/ Pink Stripe	Red
P	+12 Volt Battery Wire	Lite Green w/ Black Stripe	Yellow

**Note:** using an optional snap on wire harness adapter will simplify the wiring. Most snap on wire harness adapters have already converted and color coded the wires from the auto makers in dash wire harness to match typical aftermarket radio wire colors.

\*\* The wire colors listed in the chart above are typical for Ford vehicles during these years but may not be the exact colors for this vehicle. This is another reason to use a snap on wire harness adapter. \*\*

Publication, Duplication, or Retransmission Of This Document Not Expressly Authorized In Writing By The Install Doctor Is Prohibited. Protected By U.S. Copyright Laws. © 1997,1998,1999,2000.

## ▶ Mounting A Radio

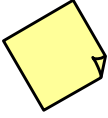

### NOTE:

This vehicle requires a special kit designed specifically for Ford Explorers and Rangers and all Ford with double sized radios.

All information needed to complete the mounting of the new radio to the vehicles dash is included on this sheet. If you need additional help, please consult the following tech documents:

Document Title	Document #
Why use radio installation kits	999005
Mounting your radio to an installation kit	999007
Radio security	999010
'DIN' vs. Shafted radio - differences with	999006

Ford Explorer/Ranger Radio  
Installation Kit

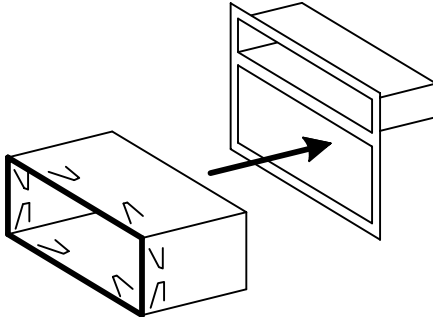

'DIN' Sleeve From New  
Replacement Radio

Slide The 'DIN' Sleeve From The New Radio Into The Kit And Bend Tabs On The Sleeve Behind The Rear Of The Kit To Secure The Sleeve To The Kit.

Opening In Dash

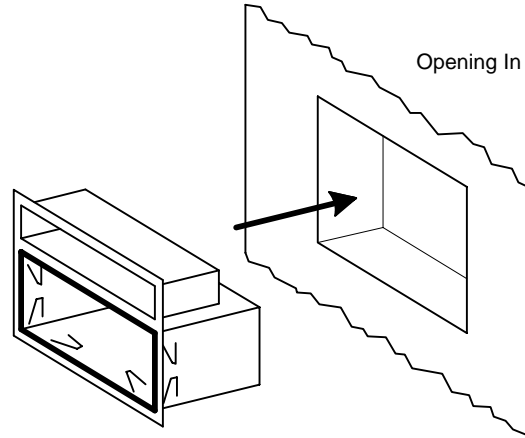

Push The Kit Into The Dash Opening Until It Snaps Into Place, Securing The Kit To The Dash.